

# zambelli

Practical, clever, professional!

## Installation instruction Roof drainage

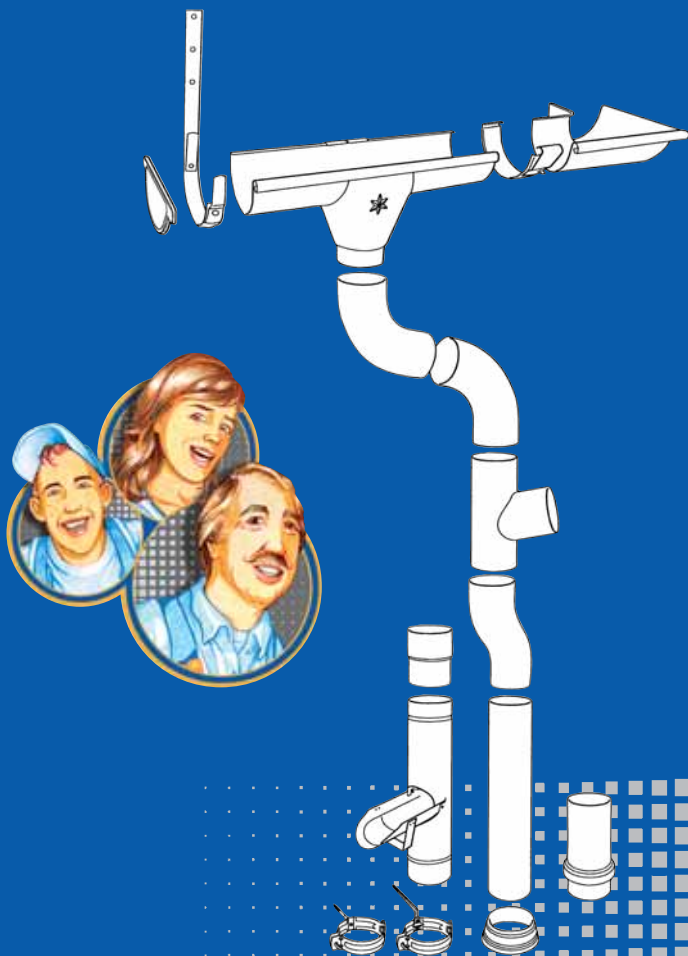

# Practical, clever, professional!

**The product range of the Zambelli gutter system matches the needs of roofers, metal roofers and plumbers as we are offering practical product innovations as well as clever problem solutions.**

Our complete range consists of sophisticated brand articles which are used for the professional installation of high-quality roof drainage.

Zambelli is the right partner for every craftsman!



## **Zambelli knows what the craftsman wants**

Fast installation, simple workmanship and reliable in function. Zambelli is working for years on these requests and came up with many product innovations. Please take also into consideration that we have several articles which you neither need to rivet nor to solder. Sophisticated push-and-stick (click-on) connections make work easier and faster.

## **Tradition for the craftsman**

Of course: soldering gun and riveting nipper are also still used. Traditional technologies, fitting accuracy and a perfect form are the main pre-conditions for professional riveting, soldering or seaming. And the quality of the installation always shows the competence of the craftsman.

**“Please ask your professional distributor about Zambelli’s practical installation solutions!”**

**By the way: Have we already introduced our three product experts? You see a master, an assistant and an apprentice - this is a small team which you can meet on the building site every day! They are the specialists for the roof.**

As their real colleagues they have one goal: to install an excellent roof drainage with the best products.



### **Zambelli makes perfect!**

Masters have to show their skills every day. If they have to work with materials and products which do not keep what they promised, it is difficult and annoying. Therefore, our master examines every product in detail. You can absolutely trust in his quality opinion! That's guaranteed!



### **Extremely clever!**

High-quality roof drainage systems grade up a building considerably. That's why the assistant swears by the design of Zambelli products. But besides a good taste she also has brains. If you want to save money or look for extreme clever solutions you should take her advice!



### **Just practical!**

Also an apprentice belongs to our craftsman-team. Although he still has to learn a lot, he already knows that everything has to be practical on the building-site. Therefore, our apprentice prefers the Zambelli products which can be installed extremely fast.



# Need of tool

## Basic tool

Bending tool for gutter hooks

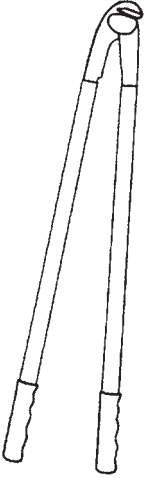

Hammer

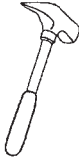

Rubber mallet

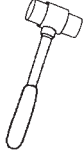

Cutter

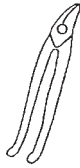

Air lever



Multigrip pliers

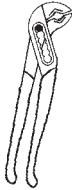

Iron for bending

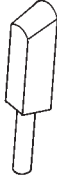

Metall saw

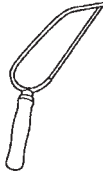

Rule and pen



Guideline



## For enlarging the pipe

Drill machine and enlarger

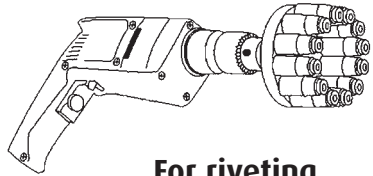

## For soldering

Soldering gun

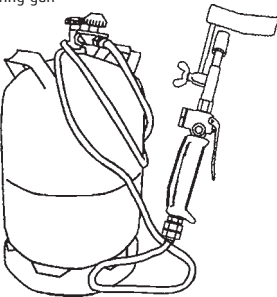

## For riveting

Riveting nipper



## Gutter

gutter, gutter connector, gutter hooks, fascia hangers, leaf protection, gutter sieve

## Gutter corner

inside corner, outside corner, box-shaped corner, corner with side length 500 mm, corner with narrow radius, corner with bead 14 mm

## Stop end

stop end for seaming, stop end for soldering, stop end for pushing on and soldering, stop end for simple push-on installation, quarter ball stop end, box stop end, box stop end for soldering

## Outlet

outlet, logo outlet, inclined outlet, hinged outlet, gutter outlet, box gutter outlet, hopper

## Downpipe

downpipe, downpipe connector, downpipe reduction, pipe cover, downpipe bracket, downpipe junction, drivepipe, sliding collar

## Elbow

elbow 40°, 60°, 72° and 85°, s-curve, beaded elbow, downpipe angle, square elbow, elbow "Vario"

## Accessories

expansion, water collector, rainwater pipe flaps, WZ-chimney hood, WZ-chimney mantle, bead, screw caps, pins, DICHT 7 glue

# Fixing/Connecting the gutter

## Installation of gutter hooks

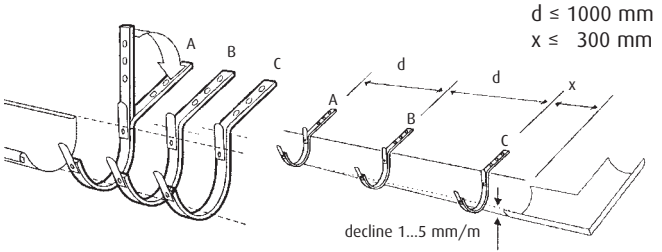

## Riveting and soldering

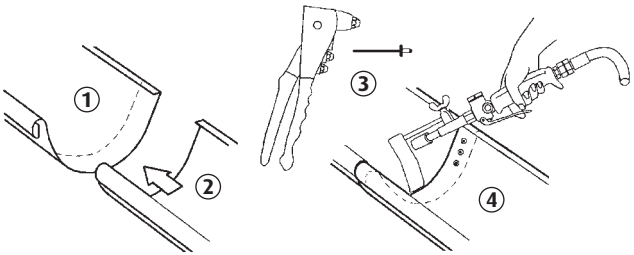

## Gutter connector

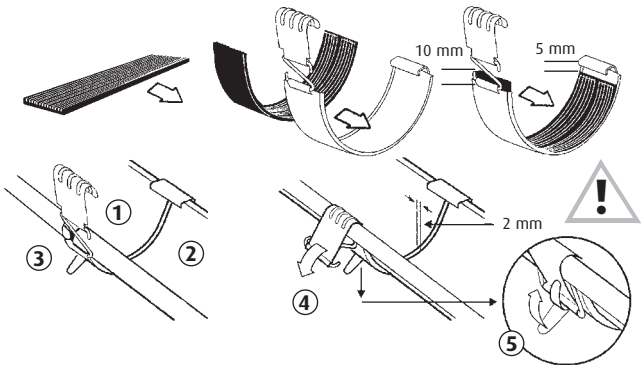

## Seaming

stop end

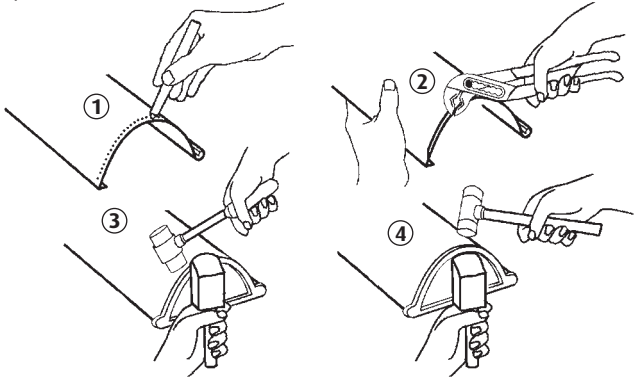

## Soldering

stop end for soldering

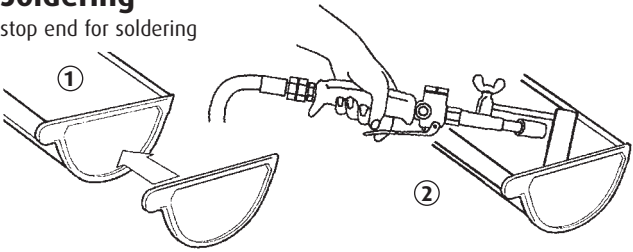

## Push-on

stop end for push-on installation

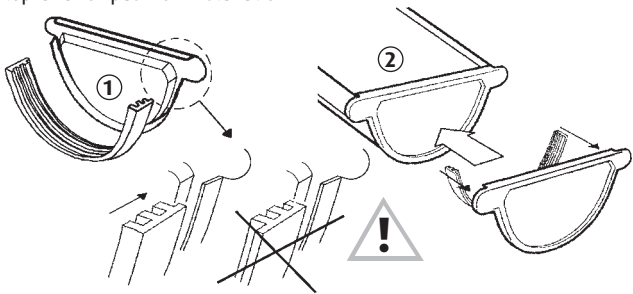

# Outlet and elbow

## Installation of outlet

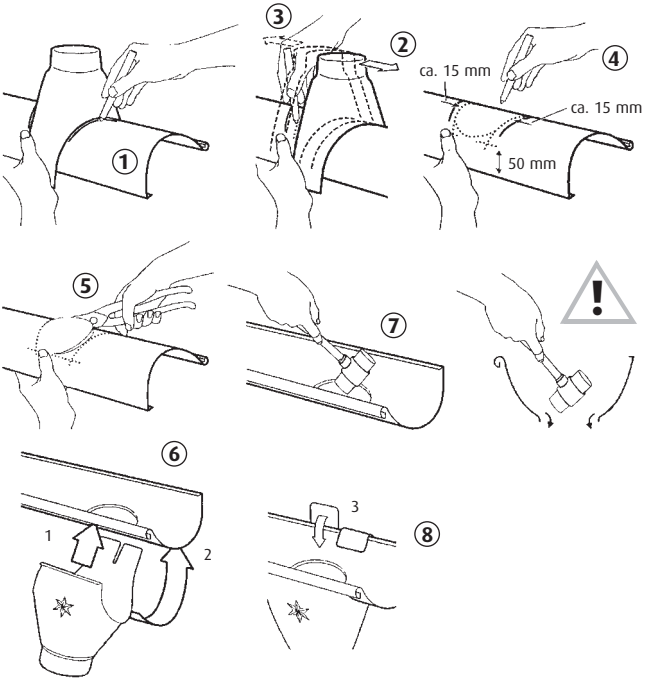

## Installation of elbow

wapping

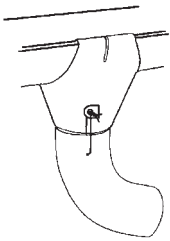

riveting

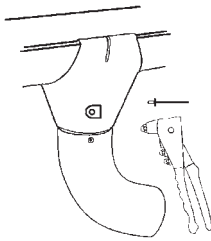

3-points-set  
(turnable and re-installable)

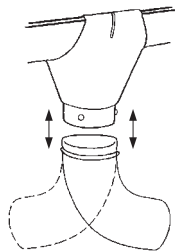



## Downpipe connections

Enlarging

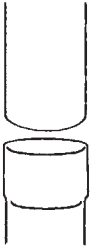

Downpipe connector

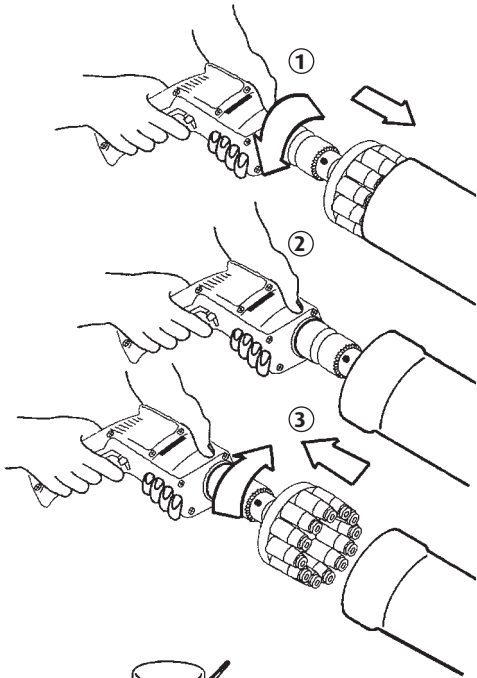
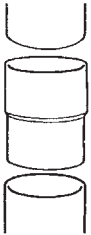

Sliding collar with leaf basket

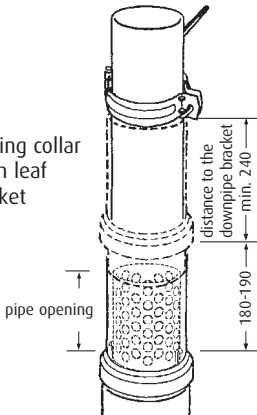

# In the pole position with three points!

It was never possible to install outlet and elbow as fast and simple as it is now – with Zambelli's 3-points-set!

**"A real master performance!**

The 3-points-set is unique in its functions. It works in this way: the elbow is simply pushed onto the outlet, it is snapped in three points and can be turned without force into every required position. If needed, the elbow can be re-installed easily and without any damage of the outlet. **The next job can come!"**



## **The craftsman is happy on the building site:**

- Outlet and elbow can be connected without using a tool. Without wrapping or riveting!
- With the 3-points-set the installation is reduced to only a few movements. This means a considerable time-saving compared to the conventional methods.
- The elbow can be moved until the completion of the job and can be easily re-installed if necessary.

# Statement of the expert

**With Zambelli products you are offering your customers high-quality brand articles. Please inform your customers about this advantage!**

You can also give them advice in finding the right material or construction. The practical material folder and the German Zambelli brochure "Bauherrenberatung" can help you. Please make also use of the convenient calculation scheme for gutter and downpipe sizes.

## **Zambelli material folder**

The Zambelli material folder contains samples of the different materials. It shows the variety of metals and makes differences comparable.

## **German brochure "Bauherrenberatung"**

The roof drainage is shown in this brochure in its complete variety of materials and forms.

## **Calculation scheme**

Calculating the needed sizes is as quick as never before. The Zambelli calculation scheme makes it possible.

**"You receive material folder, "Bauherrenberatung" and calculation scheme from your professional distributor or directly from Zambelli for free!"**





RIB-ROOF  
metal roofing systems

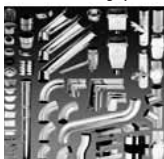

Roof drainage



Shelving systems



Roof and facade



Industrial  
metal works



Caravan supply

## Master-quality

Zambelli gutter accessories are produced according to the highest quality norms. We are exclusively working with tested and selected metals. Our production machines are modern and efficient. This guarantees the perfect fitting and the best quality of Zambelli products.

All our products are master products. You receive the Zambelli roof drainage products from our distribution partners.



Your professional distributor:

Zambelli  
Fertigungs GmbH & Co. KG  
Passauer Straße 3+5  
D-94481 Grafenau

Telefon +49 (0) 85 55 409-0  
Fax +49 (0) 85 55 409-30  
www zambelli.de